



ambient pressure diving



RB70 Automatic Diluent Valve Maintenance Manual

Version 1.1
November 2006
Written by Tino de Rijk

Table of Contents

1. Introduction	3
2. ADV diagram and parts list (Pre June 2006)	4
3. Service kit contents and special tools	5
3.1 Service kit contents	5
3.2 Special tools.....	6
4. Disassembly instructions	7
4.1 Remove retaining ring from T-piece body	7
4.2 Unscrew locking ring from T-piece body	7
4.3 Remove skid disc, diaphragm cover and diaphragm	8
4.4 Unscrew retaining screw from protruding part of ADV body.....	8
4.5 Remove banjo from protruding part of ADV body	9
4.6 Push the ADV body out of the T-piece body.....	9
4.7 Push lever pin from lever and ADV body.....	10
4.8 Screw tilt boss out of ADV body.....	11
4.9 Remove spring, tilt axle and tilt boss from ADV body.....	11
5. Replace service parts	12
5.1 Remove BS014 N70 O-ring from outside of banjo	12
5.2 Remove the two BS012 N70 O-rings from the inside of the banjo.....	12
5.3 Remove BS010 N70 O-ring from tilt boss	13
5.4 Remove BS006 N90 O-ring from tilt boss	13
5.5 Clean deposits from all metal parts (chalk, salt etc.)	14
5.6 Replace all O-rings with new ones from the service kit.....	14
6. Assembly instructions	15
6.1 Put spring, tilt axle and tilt boss in ADV body	15
6.2 Screw tilt boss back in ADV body	15
6.3 Push lever pin back through lever and ADV body	16
6.4 Push ADV body back into the T-piece body	17
6.5 Push banjo back on protruding part of ADV body	18
6.6 Screw retaining screw back in protruding part of ADV body.....	18
6.7 Replace diaphragm, diaphragm cover and skid disc.....	19
6.8 Screw locking ring back into T-piece body.....	19
6.9 Screw retaining ring back in T-piece body.....	20
7. Testing instructions.....	21
7.1 Do negative counterlung leak test (with diluent cylinder valve closed)	21
7.2 Do positive counterlung leak test.....	21
7.3 Test ADV operation by breathing from empty loop	21
7.4 Check for bubbles from T-piece body or banjo during shallow test dive	21
Annex A Replacing the retainer base rubber protector and O-ring	22
A.1 Remove the ADV from the lung	22
A.2 Re-fit the ADV to the lung	22
Annex B ADV diagram and parts list (Post June 2006).....	23

1. Introduction

The Automatic Diluent Valve (ADV) is an optional feature, specifically designed for the Ambient Pressure Diving line of Inspiration and Evolution closed-circuit rebreathers. Use with any other type of rebreather is not recommended.

It replaces the inhale T-piece on the left shoulder counterlung and is usually fitted with the diaphragm facing the diver's head. The ADV is activated by a pressure differential across the diaphragm and it supplies gas to the loop (breathing circuit) whenever a substantial negative pressure is experienced within the inhale counterlung.

The gas supply hose connects with a 3/8" UNF thread to the low pressure port on a first stage or into the diluent port of the Inspiration's manifold and connects to the ADV's 300° swivel.

The swivel allows for the hose to be fed from the rear e.g. from the manifold, from the front or from a side mounted diluent cylinder. If the side mounted cylinder needs to be removed in water the optional in-water quick release connector is available.

The ADV is an upstream valve and can be used with 1st stages delivering 7 to 11 bar (nominal 9.5 bar) above ambient and requires no adjustment. The elastomeric diaphragm cover allows manual operation.

During descents it is normal for the ADV to add gas on nearly every inhalation. However, this is most abnormal during all other phases of the dive. Normally the ADV adds gas to make the counterlung volume breathable and then stops.



WARNING: If the ADV operates on every inhalation this is an indication of either poor rebreather diving practice like exhaling through the nose or is a sign of some other leak from the loop. Any extra diluent addition usually has the effect of reducing the ppO_2 within the breathing circuit and would be countered by the oxygen controller adding oxygen to regain the setpoint.

The danger of inadvertently using excess gas from both diluent and oxygen cylinders is higher when using an ADV and extra monitoring of cylinder contents gauges should take place.

Located on the left shoulder, rolling left side down may force the ADV to add gas to the loop as will rotating head down, when the gas in the counterlungs migrates upwards away from the ADV and causes a negative pressure on the inside of the diaphragm. Whenever these manoeuvres are undertaken you may need to run the counterlungs with a higher gas volume than normal.

 The numbers between brackets after the part names in the disassembly and assembly chapters correspond to the sequence numbers in the first column of the diagram on the next page.

2. ADV diagram and parts list (Pre June 2006)

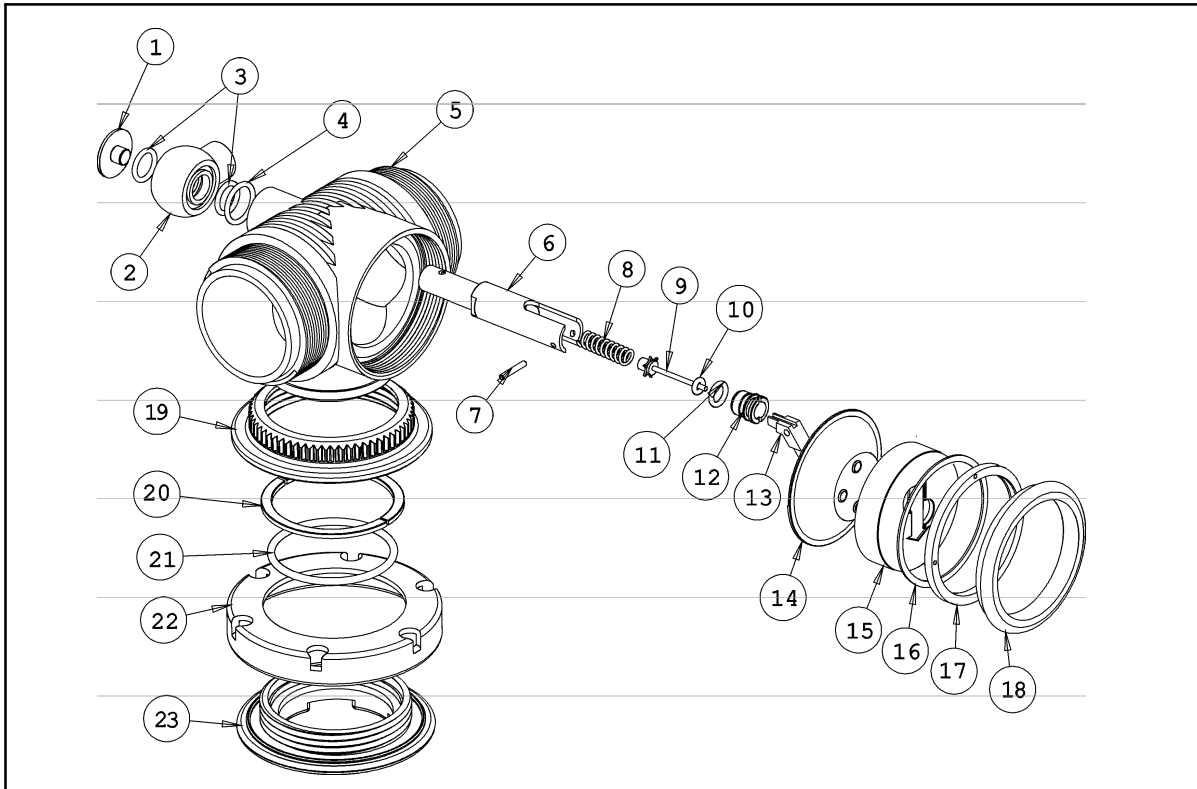

<u>NO.</u>	<u>PART NAME</u>	<u>PART NO.</u>	<u>QTY</u>
1	RETAINING SCREW	RB70/07	1
2	BANJO	RB70/05	1
3	BS012 O-RING	BS012 N70	2
4	BS014 O-RING	BS014 N70	1
5	T-PIECE BODY	RB70/01	1
6	ADV BODY	RB70/04	1
7	LEVER PIN	RB70/08	1
8	SPRING	RB70/11	1
9	TILT AXLE	RB70/13	1
10	BS006 O-RING	BS006 N90	1
11	BS010 O-RING	BS010 N70	1
12	TILT BOSS	RB70/12	1
13	LEVER	RB70/09	1
14	DIAPHRAGM	RB70/06	1
15	DIAPHRAGM COVER	RB70/10	1
16	SKID DISC	RB70/14	1
17	LOCKING RING	RB70/03	1
18	RETAINING RING	RB70/02	1
19	TOP	RB03/02	1
20	SPLIT RING	RB03/05	1
21	BS130 O-RING	BS130 N70	1
22	RUBBER PROTECTOR	RB03/04	1
23	RETAINER BASE	RB03/03	1
	10mm mesh	AP100/41	1 (not shown, goes in Banjo hose connection)

3. Service kit contents and special tools

3.1 Service kit contents



WARNING: When replacing O-rings, next to the size of the O-rings, the material and hardness of the O-rings are ESSENTIAL for proper operation. (The material designation is shown with a letter, and the hardness is expressed in degrees Shore),

For example: N denotes the material “Nitrile”. The BS006 N90 O-ring which acts as valve seat in the ADV is deliberately chosen to be harder (N90) than the other O-rings (N70) to ensure proper sealing and resistance against wear. The material and hardness of the O-rings are deliberately selected by Ambient Pressure Diving. If you choose to select your O-rings to come from another source than Ambient Pressure Diving, make sure you select the right type in size, material AND hardness.

When servicing the ADV, the following parts need to be replaced:

<u>PART NAME</u>	<u>PART NO.</u>	<u>QTY</u>
BS012 O-RING	BS012 N70	2
BS014 O-RING	BS014 N70	1

These three O-rings go in the rotating banjo.

BS006 O-RING	BS006 N90	1
BS010 O-RING	BS010 N70	1

These two O-rings go in the tilt boss.

MESH FILTER	AP100/41	1
-------------	----------	---

This goes between the regulator hose and the banjo

Optionally, the diaphragm and skid disc needs to be replaced if it is damaged or shows signs of wear and tear.

<u>PART NAME</u>	<u>PART NO.</u>	<u>QTY</u>
DIAPHRAGM	RB70/06	1
SKID DISC	RB70/14	1

Assuming the ADV is left in place on the left counterlung while servicing, no other parts need to be replaced. If the ADV is removed from the counterlung, the following parts also need to be replaced:

<u>PART NAME</u>	<u>PART NO.</u>	<u>QTY</u>
BS130 O-RING	BS130 N70	1

This O-ring sits between the retainer base (23; inside the counterlung) and the T-piece body (5).
SEE ANNEX A

RUBBER PROTECTOR	RB03/04	1
------------------	---------	---

Although it is not mandatory to replace it at every service interval, it is highly recommended replacing this rubber protector also. It plays a key role in making sure the T-piece assembly seals well against the inside of the counterlung. SEE ANNEX A

<u>PART NAME</u>	<u>PART NO.</u>	<u>QTY</u>
BS109 O-RING	BS109 N70	1

Fitted to ADV'S manufactured after June 2006, SEE ANNEX B

3.2 Special tools

Three special tools are needed for proper servicing of the ADV:

- **RBTOOL 6: T-Piece C-Spanner**

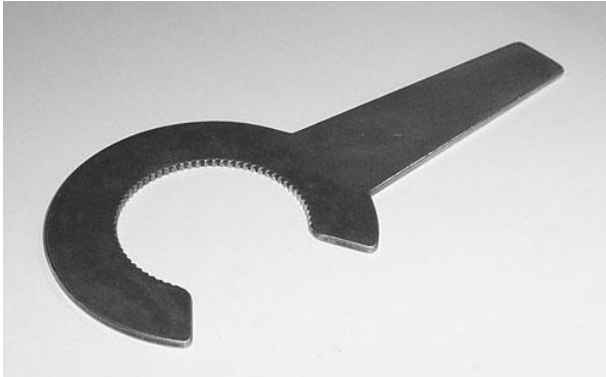

This tool is used to remove and fit the ADV from the Lung.

- **RB TOOL 8: 4-pin locking ring tool.**

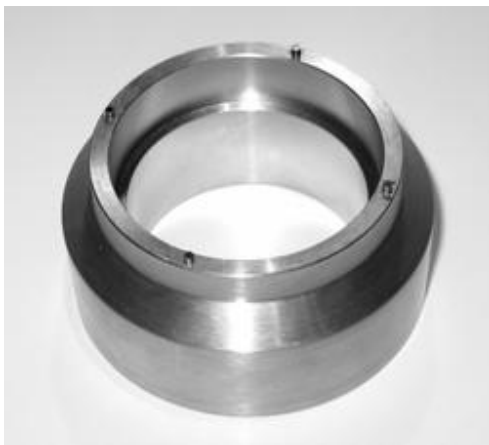

This tool is used for removing and placing back of the locking ring from the T-piece body. Using this tool avoids damaging the locking ring, which is not easy to remove using standard pliers due to the small size of the slots and the size of the locking ring.

- **RB TOOL 9: Demand valve slotted tool.**



This tool is used for removing the tilt boss from the ADV body during disassembly, and screwing it back into the ADV body during assembly. Using this tool avoids damaging the delicate tilt boss and the inside of the ADV body.

4. Disassembly instructions

4.1 Remove retaining ring from T-piece body



Unscrew counter-clockwise.

 **TIP:** use a piece of super-fine sandpaper as a cloth if you cannot get a good grip on the ring to remove it.

4.2 Unscrew locking ring from T-piece body



Unscrew counter-clockwise, using special tool RB TOOL 8 or a correct fitting pair of pliers with thin tips. Make sure that the 4 pins from the special tool are properly locked into the 4 small holes in the locking ring to avoid damaging the ring.

4.3 Remove skid disc, diaphragm cover and diaphragm



Treat the diaphragm with care. Inspect it carefully for wear and tear.
Consider that damage to the diaphragm can lead to a flooded loop of your rebreather!
When in doubt, replace.

4.4 Unscrew retaining screw from protruding part of ADV body



Unscrew counter-clockwise. Use a 5 mm Allen key.

4.5 Remove banjo from protruding part of ADV body



4.6 Push the ADV body out of the T-piece body



The BS014 O-ring on the outside of the banjo seals on the outer face of the ADV. Make sure you extract the ADV body carefully, without levering.

⚠ WARNING: Do NOT rotate the ADV body while extracting, as it is aligned to the T-piece body with small plastic notches to keep it in the correct vertical position. Rotating it might damage the plastic notches on the inside of the T-piece body.

4.7 Push lever pin from lever and ADV body

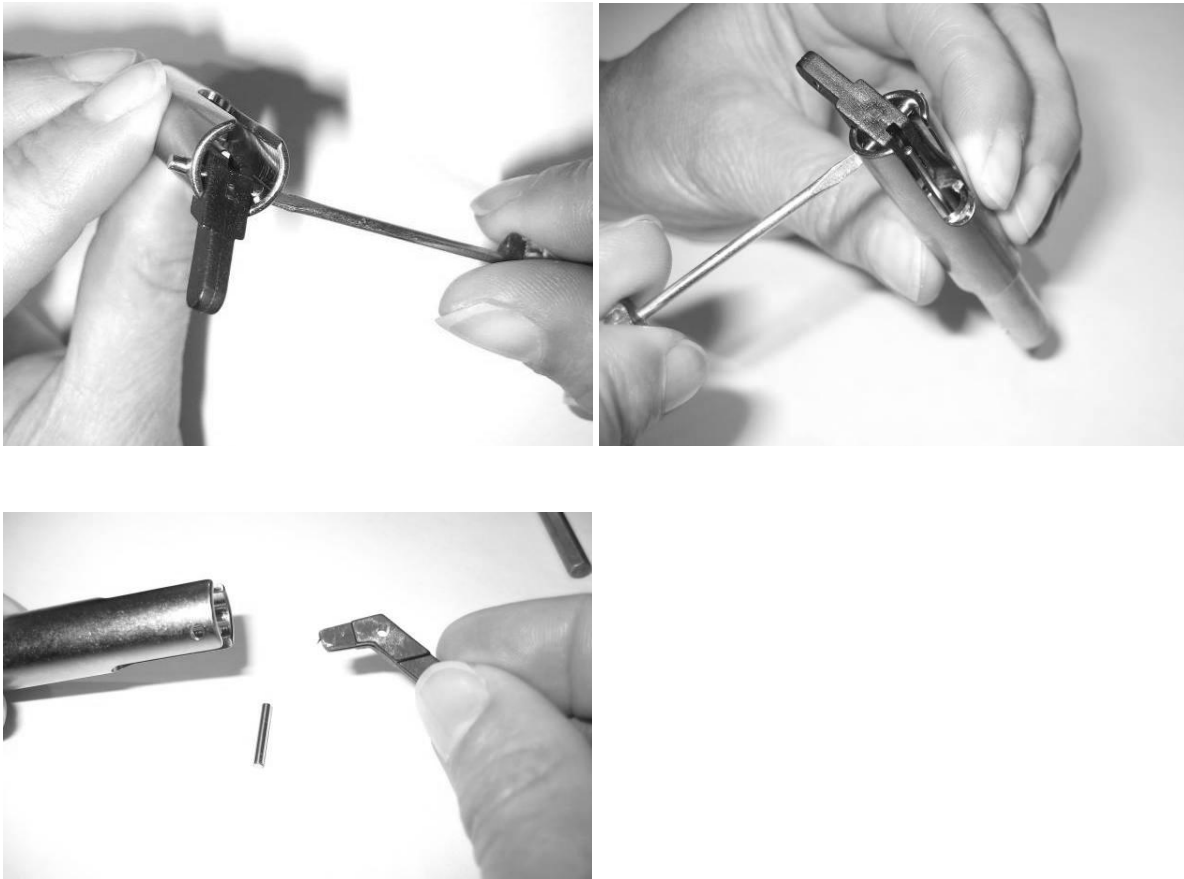

The pin holds its position in the lever solely by friction; no locking rings etc. are used. Make sure you do not damage the plastic lever if you use a small tool to push out the lever pin. Use a pair of pliers to pull the pin out once you can get hold of it.

4.8 Screw tilt boss out of ADV body



Insert the demand valve slotted tool (RB TOOL 9) into the ADV body. Make sure it connects properly into the groove on top of the tilt boss. Unscrew counter-clockwise, and take the tilt boss out of the ADV body. Make sure you do not loose the tilt axle and spring as they will now come out also.

! **WARNING:** make sure that the centre stem of the tilt axle slides into the centre hole of the demand valve slotted tool when inserting it into the ADV body. The 90° angle of the tilt axle is VITAL to the correct operation of the ADV. Bending it will lead to either free-flow or the opposite, non-delivery of diluent gas by the ADV.

4.9 Remove spring, tilt axle and tilt boss from ADV body



After removal check again if the tilt axle hasn't got bent by the removal process.

5. Replace service parts

5.1 Remove BS014 N70 O-ring and Mesh Filter AP100/41 from outside of banjo, the Mesh Filter is inside the hose connection.



5.2 Remove the two BS012 N70 O-rings from the inside of the banjo

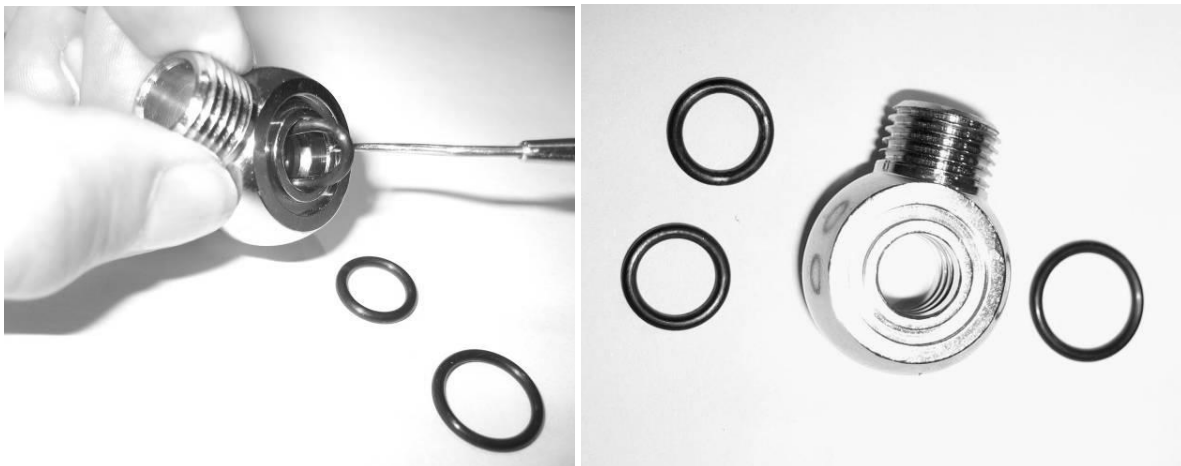

⚠ WARNING: It is almost impossible to remove these O-rings without damaging them – especially the smaller ones on the inside. Therefore NEVER re-use the old rings; always use new ones!. DO NOT use the Banjo body to lever the O-rings out, this may damage the sealing face.

5.3 Remove BS010 N70 O-ring from tilt boss

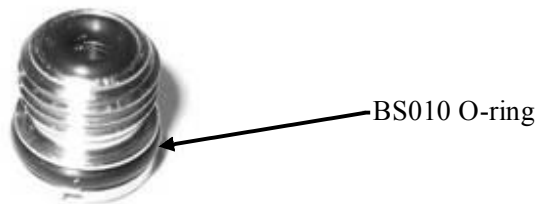

When this O-ring is damaged, diluent gas will leak into the loop. Also, removing it has a high risk of damaging it in the process. Therefore ALWAYS replace this O-ring when servicing the ADV.

5.4 Remove BS006 N90 O-ring from tilt boss



This small O-ring has a very special role. It acts as the valve seat for the tilt-axle which acts as an up-stream valve. Together with the tilt-axle they act as the core valve assembly of the ADV. Damage to this O-ring will lead to a leaking ADV. Therefore ALWAYS replace it when servicing the ADV.

⚠ WARNING: do NOT grease this O-ring. Greasing it might result in it collecting dirt from the diluent gas flowing past it and might lead to leaking.

5.5 Clean deposits from all metal parts (chalk, salt etc.)

Clean deposits from all metal parts, like chalk and salt.

Especially clean ADV body, spring, tilt axle, tilt boss and lever pin, banjo and retaining screw.



WARNING: Do NOT use aggressive chemicals. Use an ultrasonic cleaning bath instead.

5.6 Replace all O-rings and Mesh Filter with new ones from the service kit

- Replace the two BS012 N70 O-rings inside the banjo.
- Replace the BS014 N70 O-ring on the outside of the banjo.
- Replace the Mesh Filter Ap100/41 from the Banjo hose connection.
- Replace the BS010 N70 O-ring on the outside of the tilt boss.
- Replace the BS006 N90 O-ring on the inlet topside of the tilt boss.
- Optionally replace the diaphragm if it shows signs of wear and tear.



WARNING: do NOT grease the BS006 O-ring. It acts as a valve seat and might collect dirt from the diluent flowing past it when greased. This could lead to leaking due to improper sealing of the tilt axle which acts as the up-stream valve.

6. Assembly instructions

6.1 Put spring, tilt axle and tilt boss in ADV body



6.2 Screw tilt boss back in ADV body

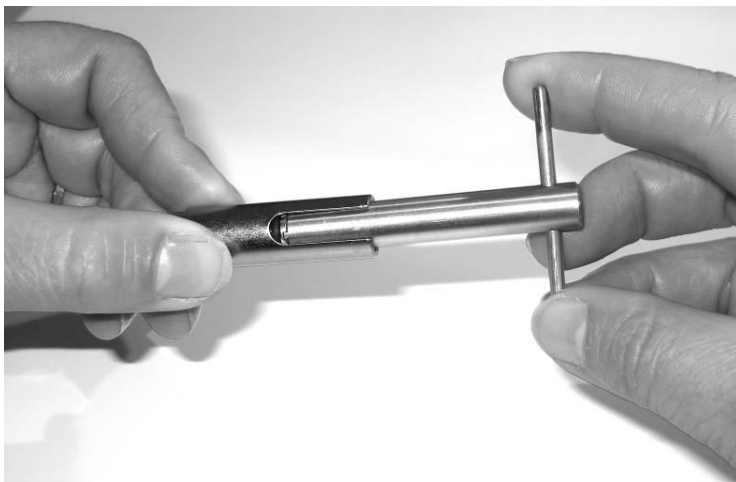

Use the demand valve slotted tool (RB TOOL 9) to screw the tilt boss back into the ADV body. Screw clockwise.

Make sure the centre stem of the tilt boss fits into the centre hole of the demand slotted tool. Also make sure it connects properly into the groove on top of the tilt boss.

⚠ WARNING: do not use force. Make sure you do NOT BEND the tilt axle! The 90° angle of the tilt axle is VITAL to the correct operation of the ADV. Bending it will lead to either free-flow or the opposite, non-delivery of diluent gas by the ADV.

Screw the tilt boss all the way in, then back off half a turn to ensure that the tilt axle is centred.

⚠ WARNING: *Backing off half a turn is the only adjustment needed for the ADV.*
Do NOT use other settings other than backing off half a turn, as it might lead to free-flow or otherwise incorrect operation or injection timing.

6.3 Push lever pin back through lever and ADV body



The pin holds its position in the lever solely by friction; no locking rings etc. are used. Try to push the pin in without using tools to avoid damaging it. If you need to use a small tool, make sure you do not damage the plastic lever or the holes in the ADV body.

⚠ WARNING: the holes in the ADV body are not in the centre, as you can see in the picture above right. The lever needs to be positioned in the lower position, pointing down. The lever also has a groove on one of its sides. The part with the groove needs to go in the inside of the ADV body, supporting the tilt axle. When positioned correctly, the tilt axle is exactly in the centre of the ADV body, and the tilt axle axis rests aligned in the groove in the top of the lever.

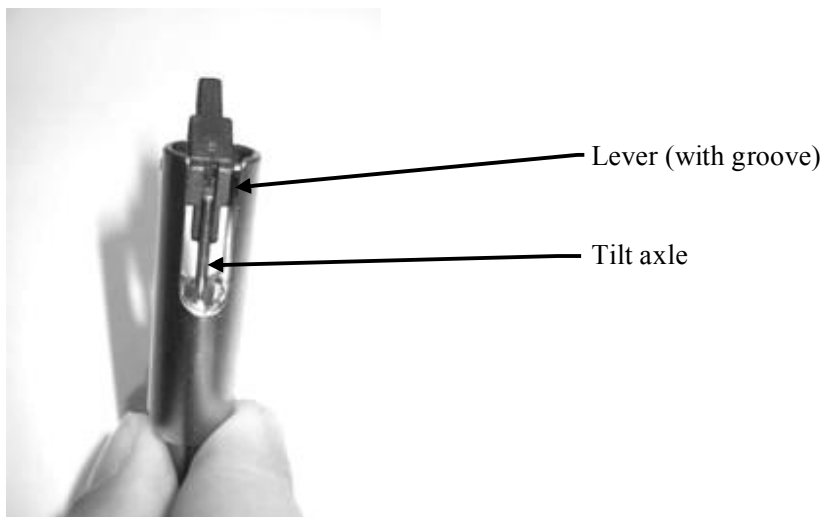

Check proper alignment and free movement of tilt axle when operating lever

6.4 Push ADV body back into the T-piece body



The BS014 O-ring on the outside of the banjo seals on the outer face of the ADV. Make sure you push it through carefully, without levering.

⚠ WARNING: Do NOT rotate the ADV body while pushing it through, as it is aligned to the T-piece body with small notches to force it in the correct vertical position. Rotating it might damage the plastic notches on the inside of the T-piece body.

If the ADV body is fitted and aligned correctly, it looks like this:



6.5 Push banjo back (2) on protruding part of ADV body (6)



Make sure the BS014 O-ring on the outside of the banjo is facing the T-piece body.

6.6 Screw retaining screw back in protruding part of ADV body

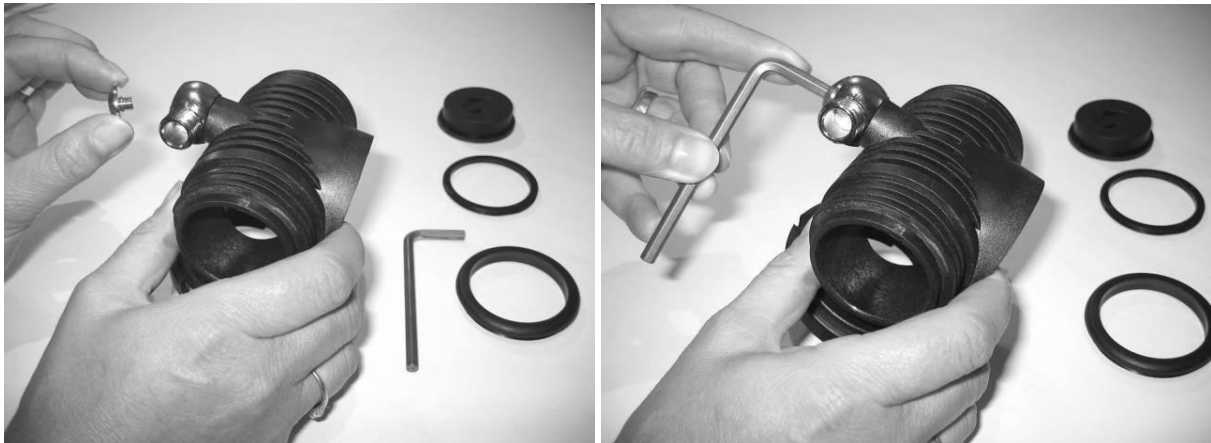

Screw clockwise. Use 5 mm Allen key to tighten until locked against ADV body.

⚠ WARNING: Do NOT over-tighten, as this might cause the ADV body to rotate and damage the notches on the inside of the T-piece body (see paragraph 6.4).

Check that banjo can swivel freely.

6.7 Replace diaphragm, diaphragm cover and skid disc

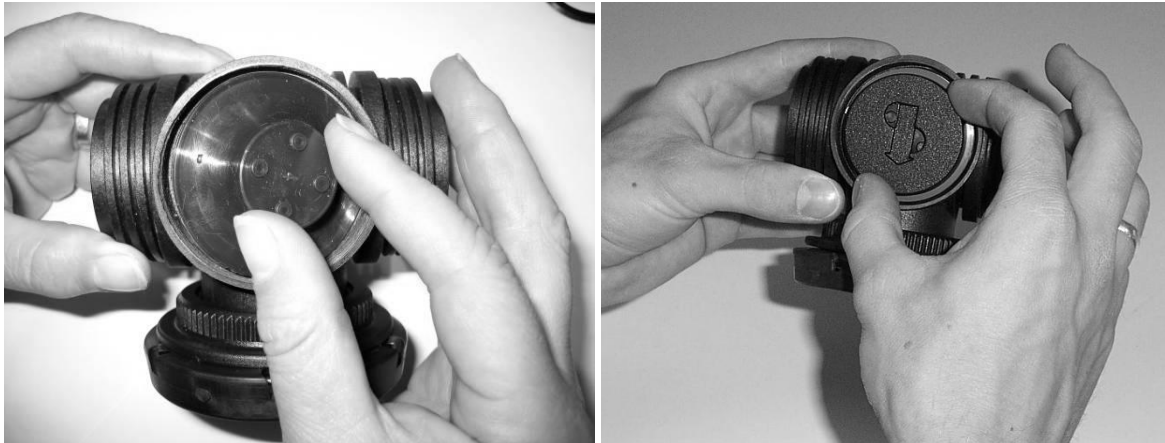

Make sure that the rim on the rear side of the diaphragm falls into the groove of the T-piece body. The skid disc can be fitted to models that previously did not have one.

6.8 Screw locking ring back into T-piece body



Screw clockwise, using special tool RB TOOL 8 or a correct fitting pair of pliers with fitting thin tips. Make sure that the 4 pins from the special tool are properly locked into the 4 small holes in the locking ring to avoid damaging the ring.

After tightening check that the diaphragm is not creased or has not come out of the groove it sits in. This can be done visually and by feel through the inside of the T-piece

6.9 Screw retaining ring back in T-piece body



Screw clockwise. Do not tighten too much, as it might make removal in the future difficult.

7. Testing instructions

7.1 Do negative counterlung leak test (with diluent cylinder valve closed)

Do your negative leak test as you would normally do when testing your rebreather, by sucking the breathing loop vacuum. You can see the diaphragm move inwards through the holes of the diaphragm cover.

During the negative leak test the diaphragm should stay in the inward position (i.e. away from the diaphragm cover). If there is a leak in the system, the diaphragm will not hold this position and return to its resting position (i.e. against the diaphragm cover).

7.2 Do positive counterlung leak test

Do your positive leak test as you would normally do when testing your rebreather, by filling the breathing loop to its maximum while keeping the overpressure valve on the right exhale counterlung in its “heavy” position (i.e. screwed in all the way towards the counterlung).

If there are leaks, the counterlungs will lose their firmness.

7.3 Test ADV operation by breathing from empty loop

Open the diluent valve. Suck the breathing loop empty. The ADV should now operate and inject diluent into the loop. Injection should stop after a few seconds when the loop has filled with diluent equal to the environmental pressure.

Judge breathing resistance by breathing softly (ADV should still open) and very hard (ADV should keep up, but must not free-flow).

7.4 Check for bubbles from T-piece body or banjo during shallow test dive

Have your buddy check the ADV for any bubbles or leaks during a shallow test dive. Rotate the banjo slightly to see if leaks also stay away under rotation.

The ADV should operate when descending as described in the Introduction chapter.

Annex A Replacing the retainer base rubber protector and O-ring

A.1 Remove the ADV from the lung



Using RBTOOL 6 to grip the Top and your hand to grip the Retainer Base through the material, unscrew the Top.

To gain access to the parts inside the lung the rear zip must be opened, the parts can then be taken out through the ADV hole in the inner bag. Do not try and pull the parts through the outer bag hole.

Replace the rubber protector and O-ring BS130 N70.

A.2 Re-fit the ADV to the lung

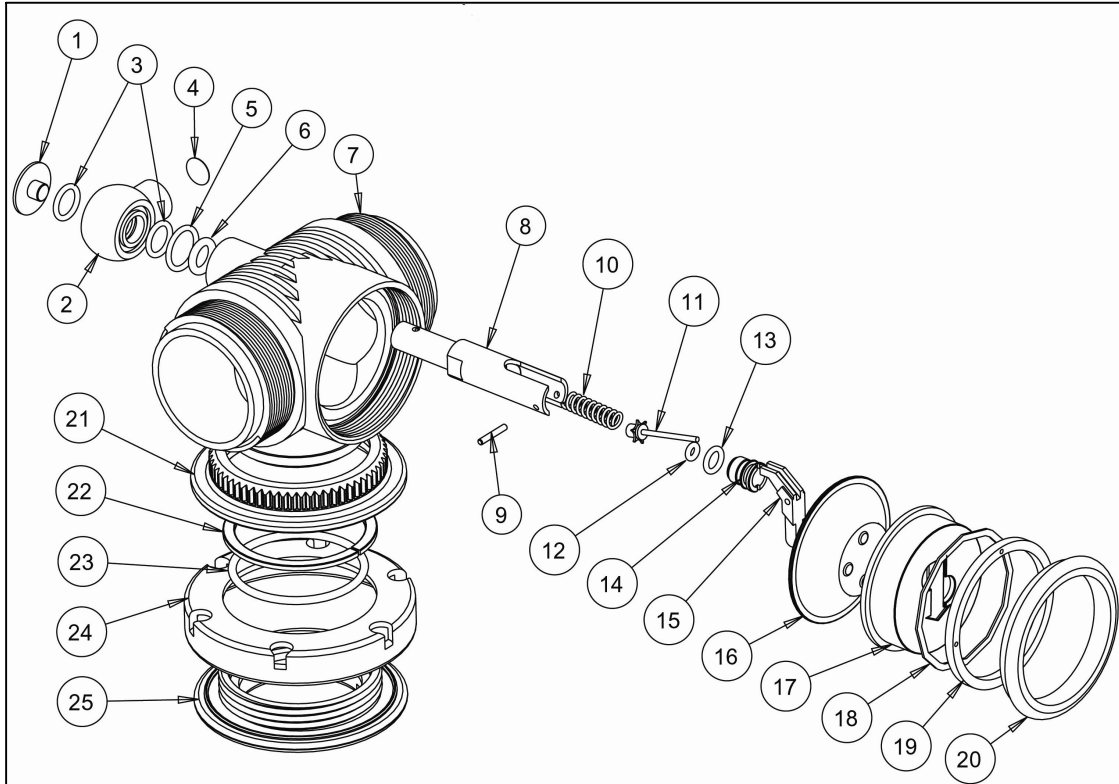

Fit the retainer base, rubber protector and O-ring BS130 N70 to the inner bag by placing the parts through the rear zip and in to the ADV hole. Once the base parts are inside the inner bag, push the base retainer screw threads through the inner and outer bag materials until the materials lay flat, ensure that the materials do not obstruct the screw threads by running the flat end of the RBTOOL 6 around the edge of the base retainer. Screw the ADV on to the base retainer and tighten up using RBTOOL 6. Close the rear zip and carry out the tests in section 7.

Annex B ADV diagram and parts list (Post June 2006)

<u>NO.</u>	<u>PART NAME</u>	<u>PART NO.</u>	<u>QTY</u>
1	RETAINING SCREW	RB70/07	1
2	BANJO	RB70/05	1
3	BS012 O-RING	BS012 N70	2
4	10mm Mesh	AP100/41	1
5	BS014 O-RING	BS014 N70	1
6	BS109 O-ring	BS109 N70	1
7	T-PIECE BODY	RB70/01	1
8	ADV BODY	RB70/04	1
9	LEVER PIN	RB70/08	1
10	SPRING	RB70/11	1
11	TILT AXLE	RB70/13	1
12	BS006 O-RING	BS006 N90	1
13	BS010 O-RING	BS010 N70	1
14	TILT BOSS	RB70/12	1
15	LEVER	RB70/09	1
16	DIAPHRAGM	RB70/06	1
17	DIAPHRAGM COVER	RB70/10	1
18	SKID DISC	RB70/14	1
19	LOCKING RING	RB70/03	1
20	RETAINING RING	RB70/02	1
21	TOP	RB03/02	1
22	SPLIT RING	RB03/05	1
23	BS130 O-RING	BS130 N70	1
24	RUBBER PROTECTOR	RB03/04	1
25	RETAINER BASE	RB03/03	1